

General Specifications

Model PH450G
pH and Redox (ORP) Converter



GS 12B07C05-01E

The EXAxt 450 series is designed to combine the superior functionality of the Yokogawa EXA series with the ease of use offered in pocket computers (PDA).

The PH450 offers the best accuracy in the industry by combining the pH measurement with advanced temperature compensation functionality, preloaded calibration standards and stability checks.

The PH450 is a true multivariable analyzer that combines pH with Temperature and ORP (Redox) measurement and all these measurements can be utilised through the different output functions: two mA current outputs, four independent SPDT contact outputs and HART®. Both DD and DTM files are available for direct connection to HART® Handheld terminal, HMI monitor and Pactware PC configurator.

The PH450 offers full functionality with PID control on either mA output(s) or on contact output(s) and with integral wash function.

Most important requirements for Electrochemical Analyzers are reliability and repeatability. This is guaranteed in PH450 sensor diagnostics impedance monitoring of both pH and reference cell. In addition to this a dynamic sensor checking coupled with the wash cycle function assure trouble free and accurate analysis with a minimum of maintenance.

Truly unique is the EXAxt450 series in the Human Machine Interface. The high resolution graphical display and the touchscreen operation make all information visible to the operator. Configuration with the touchscreen is as easy as operating a PDA. Simply choose the language of choice and on screen instructions assure that the best configuration for the application is obtained.



Features

- Easy touchscreen operation
- IP66/NEMA 4X 1/2DIN enclosure for field mounting and panel mounting
- Unique HMI menu structure in 8 languages
- Predefined buffer solutions
- Trending display up to 2 weeks
- On-screen logbooks store calibration data, configuration changes and events
- Advanced Process Temperature Compensation
- Three sets of preloaded pH buffer standards

System Configuration

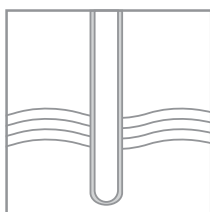

Sensors

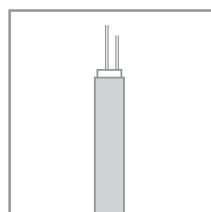

Cables

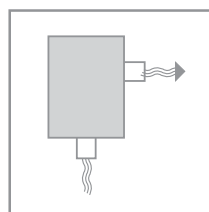

Fittings

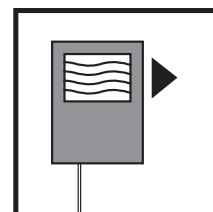

Transmitters

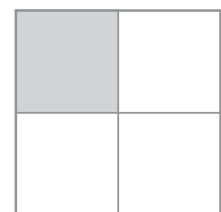

Accessories

General Specifications of EXAxt PH450

A) Input specifications: Dual high impedance input ($\geq 10^{12}\Omega$).

B) Input ranges

pH	: -2 to 16 pH.
ORP	: -1500 to 1500 mV.
rH	: 0 to 100 rH.
Temperature	
- Pt1000	: -30 to 140°C.
- Pt100	: -30 to 140°C.
- 350 Ω (DKK)	: -30 to 140°C.
- 5k1	: -30 to 140°C.
- 6k8	: -30 to 140°C.
- PTC10k	: -30 to 140°C.
- NTC 8k55	: -10 to 120°C.
- 3kBalco	: -30 to 140°C.

C) Accuracy

pH input	: ≤ 0.01 pH.
ORP input	: ≤ 1 mV.
Temperature	: $\leq 0.3^\circ\text{C}$ ($\leq 0.4^\circ\text{C}$ for Pt100)
Step response	: < 4 sec for 90% (pH 7 - pH 4).

Note on performance specifications

The following tolerance is added to above performance.

mA output tolerance: ± 0.02 mA of "4-20 mA"

D) Transmission signals

General	: Two isolated outputs of 4-20 mA. DC with common negative. Maximum load 600 Ω . Bi-directional HART [®] digital communication, superimposed on mA1 (4-20mA) signal.
Output function	: Linear or Non-linear (21-step table) output for pH, temperature, ORP or rH.
Control function	: PID control.
Burn out function	: Burn up (21.0 mA) or burn down (3.6 mA) to signal failure acc. NAMUR NE43.
	: Adjustable damping. Expire time
Hold	: The mA-outputs are frozen to the last/fixed value during calibration/ commissioning.

E) Contact outputs

General	: Four SPDT relay contacts with display indicators.
Switch capacity	: Maximum values 100 VA, 250 VAC, 5 Amps. (*) Maximum values 50 Watts, 250 VDC, 5 Amps. (*)
Status	: High/Low process alarms, selected from pH, ORP, rH and temperature. Configurable delay time and hysteresis. Failure annunciation.
Control function	: On/Off, PID duty cycle or pulsed frequency control.
Wash	: Contact can be used to start manual- or interval time wash cycles.
Hold	: Contact can be used to signal the Hold situation.
Fail	: Contact S4 is programmed as fail-safe contact.

(*)Note: When contact output current is more than 4 Amps, ambient temperature should be less than 40 °C.

F) Contact input : Remote wash cycle start.

G) Temperature compensation

Function : Automatic or manual. Compensation to Nernst equation. Process compensation by configurable temperature coefficient, NEN6411 for water or strong acids/bases or programmable matrix.

H) Calibration : Semi-automatic 1 or 2 point calibration using pre-configured NIST, US, DIN buffer tables 4, 7 & 9, or with user defined buffer tables, with automatic stability check. Manual adjustment to grab sample.

I) Logbook : Software record of important events and diagnostic data readily available in the display or through HART[®].

J) Display : Graphical Quarter VGA (320 x 240 pixels) LCD with LED backlight and touchscreen. Plain language messages in English, German, French, Spanish, Italian, Swedish, Portuguese and Japanese.

K) Shipping details

Package size : 290 x 300 x 290 mm (L x W x D)
(11.5 x 11.8 x 11.5 inch).

Package weight: Approx. 2.5 kg (5.5 lbs).

Converter weight: Approx. 1.5 kg

L) Housing

: Cast Aluminium housing with chemically resistant coating; Polycarbonate cover with Polycarbonate flexible window
: Protection IP66 / NEMA 4X / CSA Type 3S

Colour : Silver grey

PH450G-A(D)-A: IP66 cable glands are supplied with the unit

PH450G-A(D)-U: NEMA 4X close up plugs are mounted in the unused cable entry holes and can be replaced by conduit fittings as required
Pipe, Panel or Wall mounting using optional hardware

Optional conduit adapter

G1/2, 1/2NPT or M20 female

M) Power supply

PH450G-A :Ratings; 100-240 V AC Acceptable range; 90 to 264 V AC
Ratings; 50/60 Hz Acceptable range; 50 Hz $\pm 5\%$, 60 Hz $\pm 5\%$
Power Consumption; 15 VA

PH450G-D :Ratings; 12-24 V DC Acceptable range; 10.8 to 26.4 V DC
Power Consumption; 10 W

N) Safety and EMC conforming standards

 , 

Safety :EN 61010-1
CSA C22.2 No.61010-1

UL 61010-1
FM3611 Class I, Div.2, Group ABCD,T6 for Ta -20 to 55°C

EMC :EN 61326-1 Class A, Table 2
(For use in industrial locations)
EN 61326-2-3
EN 61000-3-2 Class A
EN 61000-3-3
Korea Electromagnetic Conformity Standard

Installation altitude: 2000 m or less
Category based on IEC 61010: II (Note)
Pollution degree based on IEC 61010: 2 (Note)
Note: Installation category, called over-voltage category, specifies impulse withstand voltage. Category II is for electrical equipment. Pollution degree indicates the degree of existence of solid, liquid, gas or other inclusions which may reduce dielectric strength. Degree 2 is the normal indoor environment.

O) Environment and operational conditions

Ambient temperature : -20 to +55°C (-5 - 130 °F).
Storage temperature : -30 to +70°C (-20 - 160 °F).
Humidity : 10 to 90% RH at 40°C (100 °F) (non-condensing).

Data protection : EEPROM for configuration data and logbook. Lithium cell for clock.

Watchdog timer : Checks microprocessor.
Power down : Reset to measurement.
Automatic safeguard : Auto return to measuring mode when touchscreen is untouched for 10 min.

Model and Suffix Codes

[Style: S2]

Model	Suffix code	Option code	Description
PH450G	-----	-----	pH / ORP Converter
Power	- A - D	-----	AC version (100...240 VAC) DC version (12...24 VDC)
Type	- A - U	-----	General purpose version FM version
Mounting Hardware	/UM /U	-----	Universal mounting kit (panel, pipe, wall) Pipe and wall mounting hardware (*2)
Hood	/PM /H5	-----	Panel mounting hardware (*2) Awning hood (stainless steel) (*2)
Conduit adapter	/AFTG /ANSI /AM20	-----	G1/2 (*2) 1/2NPT (*2) M20 (*2)
Tag Plate	/SCT	-----	Stainless steel tag plate (*1)

Notes:

*1 If the tag number is predefined with the purchase, Yokogawa will inscript the tag plate with the specified tag number, and program the tag number in the converter.

*2 Option codes /U, /PM, /H5, /AFTG, /ANSI and /AM20 are not specified for FM version (-U).

Display and Operating Interface

The Display is a backlight graphical display with QVGA resolution. Operation is done by a touchscreen. Graphical keys on the right and other area's of the touchscreen respond to contact as virtual push buttons.

Main screen

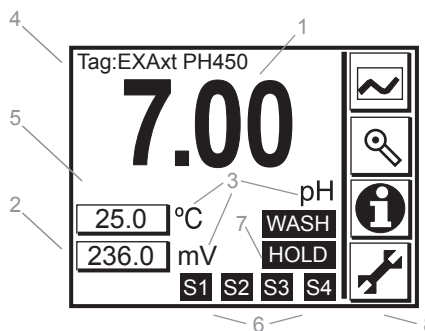

The main screen displays:

- 1 The primary variable in large font (user selectable)
- 2 Other process variable(s) in small font
- 3 Unit symbols
- 4 Tag number (user programmable)
- 5 Process description (user programmable)
- 6 Status of alarm output(s)
- 7 Status indicator during HOLD and WASH situation
- 8 Main function keys



Trend screen

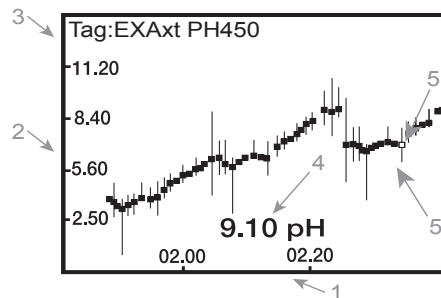

The trend screen displays:

- 1 Time scale. User selectable (between 15 minutes and 2 weeks)
- 2 PV scale. User selectable
- 3 Tag number
- 4 Actual Primary Value
- 5 Average, maximum and minimum Primary Value in this interval (time scale / 51)



Zoom screen

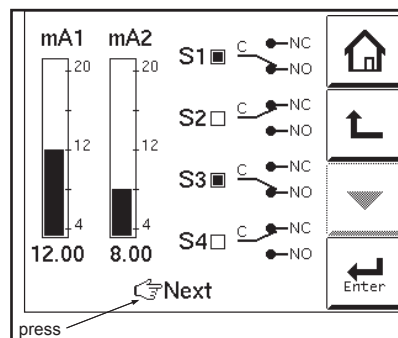

The zoom screen displays an easy graphic representation of the output functions. When "Next" is pressed it will give access to the logbook data.



Status screen

The Status screen gives access to diagnostic information with regards to analyzer or sensors.



No malfunction detected.



Soft alarm detected. Maintenance is recommended for best accuracy.



Hard alarm is detected indicating malfunction that is critical for good analysis. When this key is pressed details are displayed with regards to detected malfunction and troubleshooting guidelines are displayed to resolve the malfunction.

Most applicable error: Input 2 impedance too high	Home	Sensor fouled. Liquid earth disconnected. Sensor not immersed. Insufficient electrolyte.	Home
Explanation ◆ Advanced troubleshooting	Enter	Remedy Clean or replace sensor. Check sensor immersion. Check electrolyte reservoir. Check cables and connections.	Enter



Maintenance screen

The maintenance screen gives access to calibration, commissioning and setup of the instrument. These levels can be protected by passwords.

Read logbook: Sensor data Output data	Home	EXAxt PH450	Home
Calibration mAt	Enter	Execute: ◆ Calibration / Wash ◆ HOLD	Enter
	Enter	Setup: ◆ Commissioning ◆ Change language ◆ Service	Enter

Functionality Characteristics

Safe operation

EXAxt450 features BURN-OUT functionality according to NAMUR Recommendation 43. This document recommends to use the mA Output for fault detection by controlling the mA output in the following way:

4-20 mA: scaled to measuring range

3.8-4 mA for underflow detection

20- 20.5 mA for overflow detection

=<3.6 mA for fault detection

=>21 mA for fault detection

Input circuitry

The input circuitry of the PH450 is a dual-amplifier system with liquid earth. Measuring electrode and reference electrode inputs are amplified separately against the liquid earth contact. Following a differential amplifier, normal signal processing takes place. This configuration provides the best immunity to noise, stray solution potentials and earth loops.

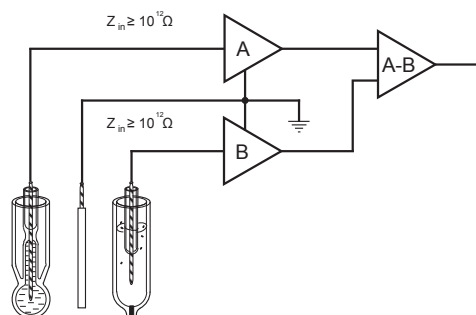

Dual amplifier system

The input amplifiers both have a very high input impedance ($>=10^{12}$ ohms). This means the PH450 is capable of accepting glass, enamel and metal measuring and reference sensors. Together with the ability to configure the ITP (isothermal point), the system can be adapted to accept almost all sensor types.

Temperature compensation

EXAxt 450 offers automatic temperature compensation. To ensure full compatibility with most commercially available pH sensors it is possible to choose out of eight different temperature sensing elements.

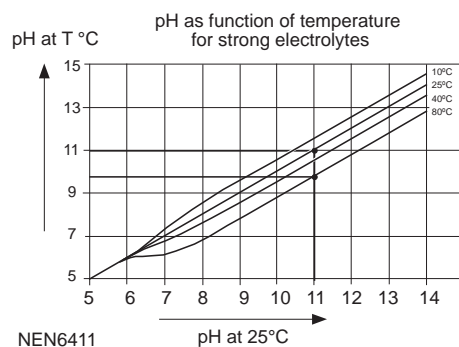

All elements have been calibrated during initialisation of the analyzer. The default configuration of the PH450 uses Pt1000 RTD for temperature compensation.

The temperature compensator is used to correct for the slope (sensitivity) of the pH sensor dependence on temperature.

In addition to this NERNST compensation function the PH450 also offers advanced temperature compensation for the process pH dependence on temperature.

Water, weak acids, weak alkali's make the pH change as function of temperature without changing the chemistry of the sample. This temperature function is often undetected and uncompensated and results in substantial process control and analyzer validation problems.

PH450 offers three additional modes for advanced temperature compensation:

- 1) Full compensation for strong acids and alkali's using NEN6411 algorithm.
- 2) Linear temperature coefficient setting
- 3) Matrix temperature compensation

1) NEN6411

This algorithm takes into account the dissociation of water in strong acid and alkaline solutions. This function is especially useful for pH measurement in Pure and Ultrapure water as found in Power Generation Water Chemistry.

2) Linear temperature coefficient

This function is used when the water chemistry is unknown. Therefore the temperature coefficient is determined empirically by taking a sample, reading pH and temperature at two different temperatures. The TC to be programmed is defined as $\Delta\text{pH}/\Delta\text{T}$. In words: the PH drift over a temperature span of one degree Celcius.

3) Matrix temperature compensation

This function is used when the empirical method has shown that the temperature coefficient varies within the measuring range of the analyzer. Then a Matrix is built of 25 points, where the pH of 5 different samples is recorded for 5 different temperatures.

WASH

The wash function is used primarily to activate a pump or solenoid that brings cleaning fluid in contact with the pH/ORP sensor to remove deposits from the process. Most scaling deposits can easily be removed by dipping the sensor in a acid solution. That is why the PH450 features an automatic HOLD function during wash operation. This results in constant output of the analyzer during the wash operation.

During the wash operation one of the four contact outputs can be used to activate the pump or open the solenoid.

The wash cycles can be started by using a programmed timer, by closing the input contact or manually from the keypad.

After the wash operation is ended the PH450 is able to monitor the dynamic response of the sensor as a dynamic sensor checking function. This feedback on the wash operation guarantees optimal usage of cleaning fluid while maintaining good responsive pH function.

Control and Alarm Functions

Both mA-outputs have the following generic functions: Control (PID), Output (Linear or Non-linear by table), Simulate (percentage output) and Off.

Control (PID control on both the mA outputs)

Proportional control action produces an output signal that is proportional to the difference between the Setpoint and the PV (deviation or error). Proportional control amplifies the error to lead the process value towards the desired Setpoint. Proportional control will reduce but not eliminate the error. Therefore, proportional control action includes a manual reset. The manual reset is used to eliminate the steady state error. Integral control will accumulate Setpoint and process (load) changes. The integral term is provided with an anti wind-up function. When the output of PI portion of the controller is outside the control range (less than -5% or greater than 105%), the I-part is frozen.

Derivative control acts on the slope (rate of change) of the process value, thereby minimizing overshoot. It provides "rate" feedback, resulting in more damping.

Adjustable parameters: Setpoint, Range, Direction, I-time, D-time (Manual reset only for P-control)

All four SPDT Contacts have the same generic functions:

Control, Alarm, HOLD, Wash, Fail, Simulate and Off

PID duty cycle control

The functionality is the same as the mA-output control function except for the fact that the contact is used to control the time a solenoid dosing valve is opened. The PID control is achieved by opening and closing the solenoid valve and varying the ratio of on and off time (T_{on} , T_{off}).

Adjustable parameters: Setpoint, Range, Direction, I-time, D-time (Manual reset only for P-control). Total time of the pulse period (1 to 999 seconds)

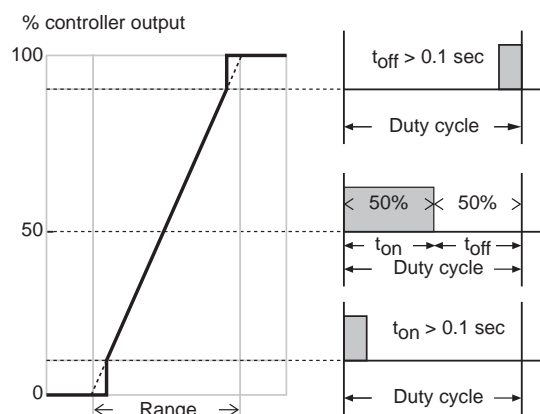

PID pulse frequency control

The functionality is the same as the mA-output control function except for the fact that the contact is used to control a pulse driven dosing pump. The frequency of pulses regulates the pump speed.

Adjustable parameters: Setpoint, Range, Direction, I-time, D-time (Manual reset only for P-control). Pulse frequency (1 to 120 pulses per minute)

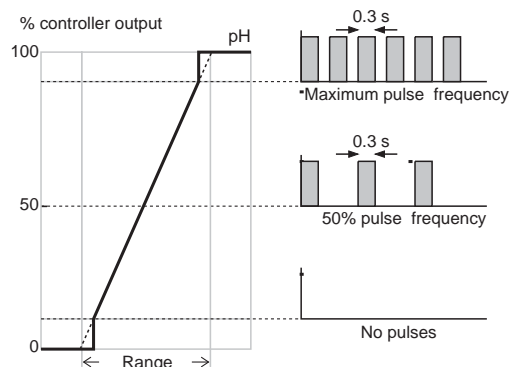

Process alarm

The contact will be switched (energized) when the process value exceeds the preset alarm limit. This can either be a high or low limit. Adjustable parameters: Setpoint, Direction, Hysteresis, Delay time, Expire time

Fail alarm

Any contact can be set to function as an alarm, indicating that the EXAxt has found a fault in the measuring loop. If the self diagnostics of the EXAxt indicates a fault or error, the FAIL contact will be switched (energized).

Wash, Chemical- or mechanical cleaning of sensors:

A contact can be used to control the wash cycle.
Adjustable parameters: Cleaning time or washing time (T_w) Recovery time after washing (T_r) interval time for wash cycle. An on-line dynamic response test of the electrode can be activated after cleaning. The response time is a good diagnostic tool to see the condition of the electrode system. During the recovery time the response is monitored and an error is generated when the "half time value" was not reached within $1/3$ of the recovery time.

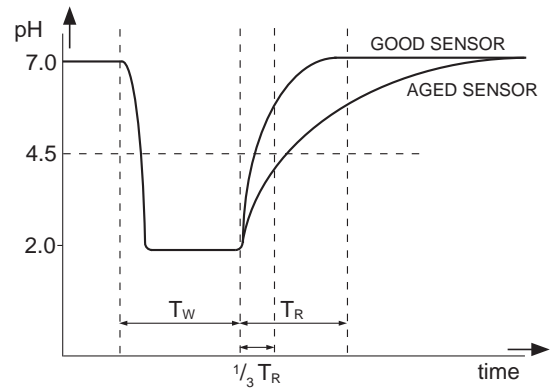

Dynamic response check after wash

Dimensions and Mounting

Unit: mm (inch)

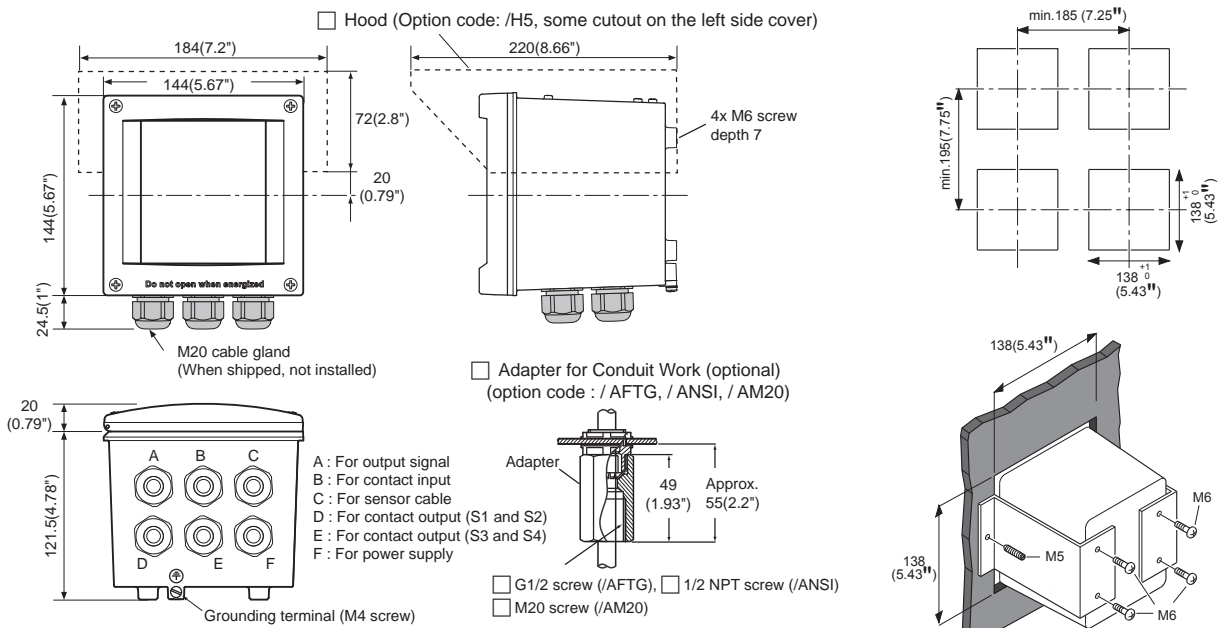

Housing dimensions ,layout of glands and conduit adapter

Option /PM: panel mounting diagram

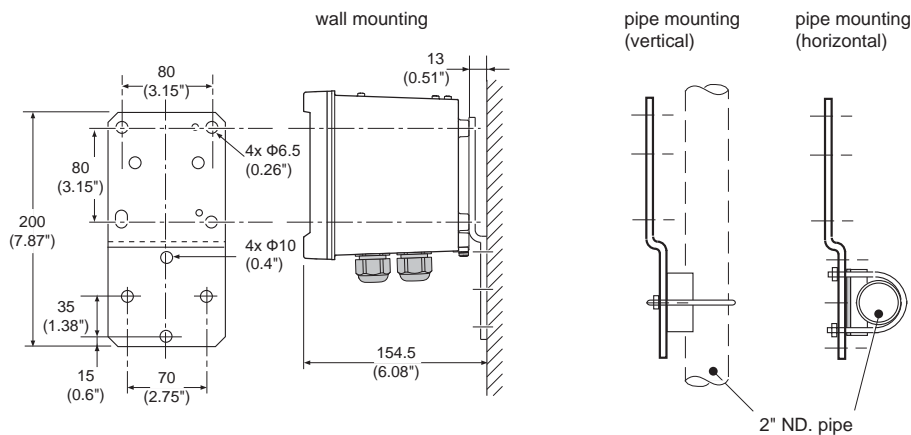

(Note)When option code "/UM" is specified, universal pipe/wall/panel mounting kit are supplied---same as option code "/U" and "/PM" both specified.

Option /U: wall and pipe mounting diagram

Wiring Diagrams

Relay Contacts

32	31	33	42	41	43	250V / 5A AC / DC	52	51	53	72	71	73		
NC	C	NO	NC	C	NO	100VA / 50W	NC	C	NO	NO	C	NC		
S1			S2			CONTACTS			S3			S4 (fail-safe)		

Signal mA Outputs

Sensor Inputs

63	66	65	62	61	22	21	11	12	14	13	17	15	16		
SHLD	-	+	-	+			+	-		IMP. LOW	IN	SHLD	IMP. LOW	IN	SHLD
mA2				mA1 (+HART)		CONTACT	TEMP		LE	INPUT 2		INPUT 1			
mA OUTPUTS										SENSOR(S)					
REFER TO INSTRUCTION MANUAL FOR CONNECTIONS													PH		

Power Supply PH450G-A
(AC power)

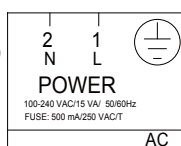

(Terminals are M3 screw)

PH450G-D
(DC power)

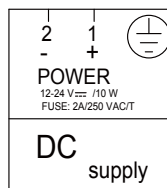

Inquiry Specifications Sheet for PH450G pH and Redox(ORP) Converter System

Make inquiries by placing checkmarks (✓) in the pertinent boxes and filling in the blanks.

1 General Information

Company name; _____
 Contact Person; _____ Department; _____
 Plant name; _____
 Measurement location; _____
 Purpose of use; Indication, Recording, Alarm, Control
 Power supply; _____ V AC DC

2 Measurement Conditions

(1) Process temperature; _____ to _____ Normally _____ [°C]
 (2) Process pressure; _____ to _____ Normally _____ [kPa]
 (3) Flow rate; _____ to _____ Normally _____ [l/min]
 (4) Flow speed; _____ to _____ Normally _____ [m/s]
 (5) Slurry or contaminants; No, Yes _____
 (6) Name of process fluid; _____
 (7) Components of process fluid; _____
 (8) Others; _____

3 Installation Site

(1) Ambient temperature; _____
 (2) Location; Outdoors, Indoors _____
 (3) Others; _____

4 Requirements

(1) Measuring range; pH 0 to 14 _____
 (2) Transmission output; 4 to 20 mA DC _____
 (3) System configuration selection; Electrode, Holder, pH Converter, Cleaning system, Terminal box,
 Accessories
 (4) Electrode cable length; 3m, 5m, 7m, 10m, 15m, 20m, ____m
 (5) Electrode operating pressure; 10 kPa or less, Greater than 10 kPa
 (6) Type of holder; Guide pipe, Submersion, Flow-through, Suspension, Angled floating ball,
 Vertical floating ball
 (7) Cleaning method; No cleaning, Ultrasonic cleaning, Jet cleaning, Brush cleaning
 (8) Sample temperature; -5 to 105°C, -5 to 100°C, -5 to 80°C
 (9) Others; _____